

pFlow

Multipath Ultrasonic Flowmeter D348D Plus

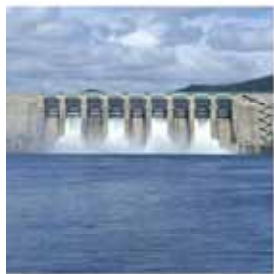

About D348D Plus

The Model D348D Plus Ultrasonic Flowmeter is a state-of-the-art universal transit-time flowmeter designed using ARM COMA technology and low-voltage broadband pulse transmission. While principally designed for clean liquid applications, the instrument is tolerant of liquids with the small amounts of air bubbles or suspended solids found in most industrial environments.

Comparing With other traditional flowmeter or ultrasonic flowmeter, it has distinctive features such as high precision, high reliability, high capability and low cost, the Flowmeter features other advantages:

With ARM COMA chip, low power consumption, high reliability, anti-jamming and outstanding benefits.

User-friendly menu designed. Parameters of pipe range, pipe material, pipe wall thickness, output signals, etc. can be conveniently entered via the windows. British and Metric measurement units are available.

With the TF Card, 512 files can be stored; the time interval can be within 1 second. Parallel operation of positive, negative and net flow totalizer with scale factor and 7 digit display. Internally configured batch controller makes batch control convenient.



Production Scene(Spool Piece)



We have a 3000m² pipeline processing plant , the whole processing include the stainless steel plate cutting, reel pipe, welding and flange mating, then to polishing and pickling etc...

Non-destructive testing is districtly carried out during the whole process of welding. With material testing report, it could reach to the design requirements.

Specification

Performance specifications	
Flow range	0.01~7m/s(0.03~23ft/s)
Accuracy	Spool piece type:±0.2%of measured value Insertion type:±0.5%of measured value
Repeatability	Spool piece type:0.07%
	Insertion type:0.15%
Pipe size	Spool piece type:100mm~600mm(4"~24") 600mm above need additional customization Insertion type:100mm~5000mm(4"~200")
WiFi	Frequency range:2.4-2.4835GHz Transmit power:12-14dBm Transmission distance:15-20m (without any obstacle) Wireless standard:IEEE802.11n, IEEE802.11g, IEEE802.11b
Function specifications	
Outputs	Analog output:4~20mA, max load: 750Ω Pulse output:0~9999Hz, OCT output (adjustable) Relay output:125VAC@1A or 30VDC@2A Communication:RS232/RS485 Communication Interface, Support Modbus Protocol
TF Card	Max record: 4GB Storage time interval: 1 ~13000 s
Power supply	90~250VAC,48~63Hz or 10~36VDC
Keypad	24 light tactile keys
Display	4.7 inch TFT color screen(English/Traditional Chinese/Simplified Chinese)
Temperature	Transmitter:-10℃~60℃(14°F~140°F) Transducer:-40℃~80℃(-40°F~176°F)
Humidity	Up to 99% RH,non-condensing
Physical specifications	
Transmitter	Die-cast aluminum, IP65
Transducer	Protection grade:IP68,encapsulated design The standard length of cable: 9m
Weight	Transmitter:1kg

Wiring Diagram

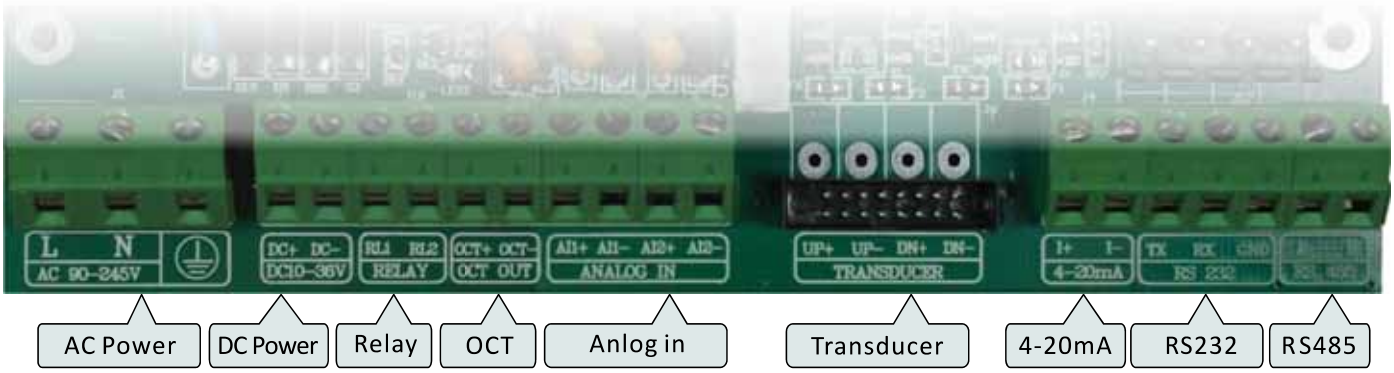

Applications



DN800 Water Supply



Insertion Transducer Installation



DN1000 Circulation Cooling Water



Sewage Treatment



Power Plant Circulation Water

Transmitter Dimensions

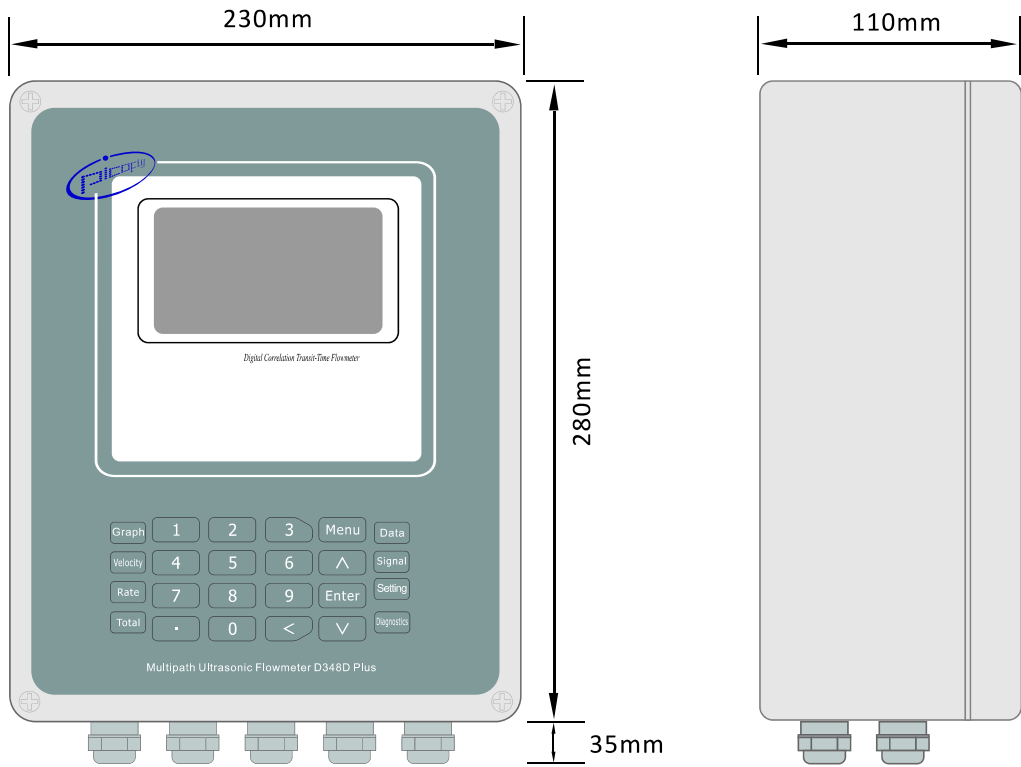

Transducer Dimensions

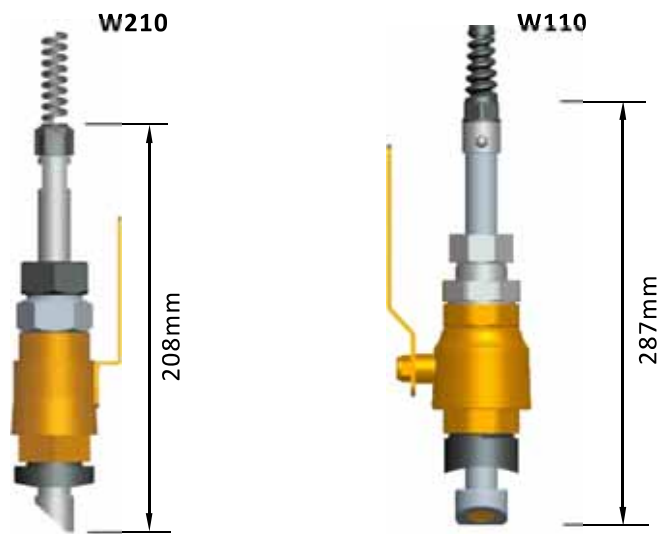

Remarks:

D348D Plus-W210 Pipe size:150-1200mm

D348D Plus-W110 Pipe size:150-3000mm

Flange Dimensions



Pipe Material: Carbon steel

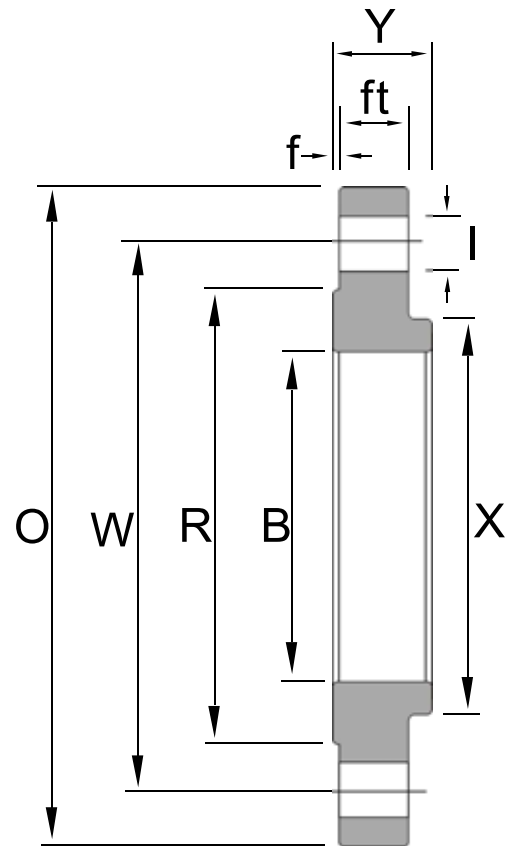

NPS	DN	Overall Diameter O	Diameter of Circle Holes W	Bolt Hole Diameter I	Number of Holes n	Face Diameter R	Raised Face f	Flange Thickness ft	Threaded/s lip-on/socket Welding Y	Hub Diameter X	Inside Diameter B
4	DN100	230	190.5	19.1	8	157.2	2	23.9	32	135	116.1
5	DN125	255	215.9	22.3	8	185.7	2	23.9	35	164	143.8
6	DN150	280	241.3	22.3	8	215.9	2	25.4	38	192	170.7
8	DN200	345	298.5	22.3	8	269.9	2	28.6	43	246	221.5
10	DN250	405	362.0	25.4	12	323.8	2	30.2	48	305	276.2
12	DN300	485	431.8	25.4	12	381.0	2	31.8	54	365	327.0
14	DN350	535	476.3	28.6	12	412.8	2	35.0	56	400	359.2
16	DN400	595	539.8	28.6	16	469.9	2	36.6	62	457	410.5
18	DN450	635	577.9	31.8	16	533.4	2	39.7	67	505	461.8
20	DN500	700	635.0	31.8	20	584.2	2	42.9	71	559	513.1
24	DN600	815	749.3	35.0	20	692.2	2	47.7	81	663	616.0

The above Chart quotes the ASME B16.5-2009 flange.

P64: Chart 4 - Flange processing surface dimensions

P71: Chart 7 – 150 Grade flange drill template

P73: Chart 8 - 150 Grade Flange dimensions

Spool piece Dimensions

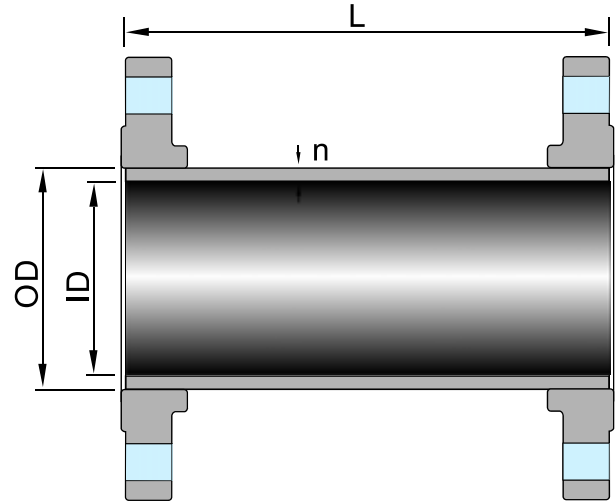

Pipe Material: Carbon steel

NPS	DN	Length L	Outer Diameter OD	Inner Diameter ID	Thickness n	Flang Weight KG	Spool Piece Weight KG
4	DN100	400	114.30	102.26	6.02	5.7	18.8
5	DN125	420	141.30	128.20	6.55	6.5	22.7
6	DN150	450	168.30	154.08	7.11	7.7	29.0
8	DN200	510	219.10	202.74	8.18	12.2	46.5
10	DN250	580	273.00	254.46	9.27	16.2	66.5
12	DN300	640	323.80	304.74	9.53	25.0	97.2
14	DN350	680	355.60	336.54	9.53	33.7	122.5
16	DN400	740	406.40	387.34	9.53	41.6	151.8
18	DN450	780	457.00	437.94	9.53	46.2	173.9
20	DN500	860	508.00	488.94	9.53	59.5	219.9
24	DN600	980	610.00	590.94	9.53	83.2	303.4

The above Chart quotes the ASME B36.10M-2004 flange.

P5: Chart 1 – The weld and rolled seamless steel tube dimension and weight

Remarks:

We also provide the DIN, JIS EN and other different standard pipe and flange.

Here customer need to provide operation standard and drawing, then the prices are re-definition.

Customer also need to provide operation standard and drawing for large pipe and flange.

Transducer Installation Methods

V method measuring pipe size : 100mm-1200mm

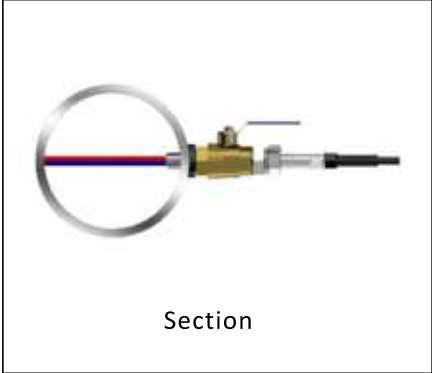
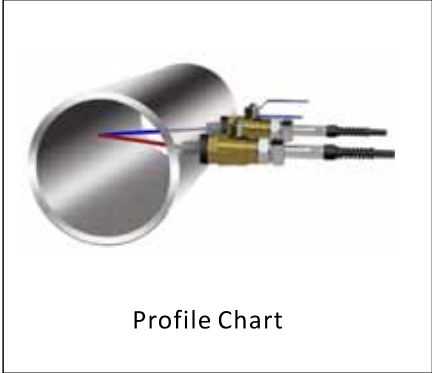

Z method measuring pipe size: 100mm-3000mm

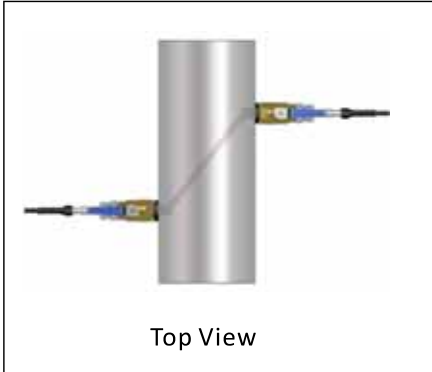
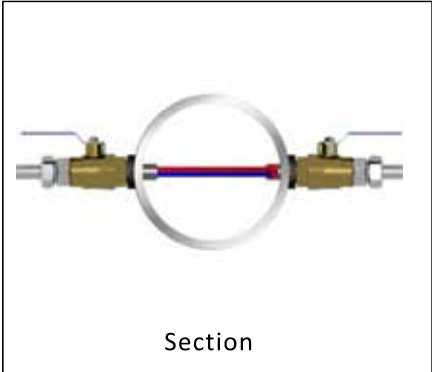
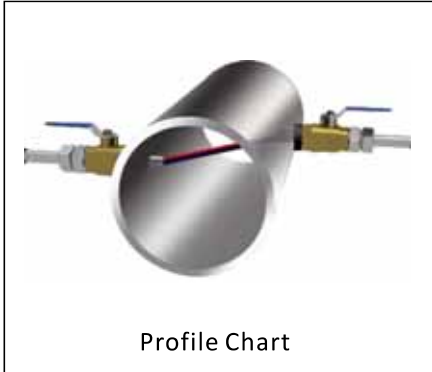

Test By The Third Party

According to the customer's requirement, products can be tested by the third party.



Installation Site Selection

When selecting a measurement site, it is important to select an area where the fluid flow profile is fully developed to guarantee a highly accurate measurement. Use the following guidelines to select a proper installation site:

Choose a section of pipe that is always full of liquid, such as a vertical pipe with flow in the upward direction or a full horizontal pipe.

Ensure enough straight pipe length at least equal to the figure shown below for the upstream and downstream transducers installation.

Ensure that the pipe surface temperature at the measuring point is within the transducer temperature limits.

Consider the inside condition of the pipe carefully. If possible, select a section of pipe where the inside is free of excessive corrosion or scaling.

Straight length of upstream piping

90° Bend



Tee

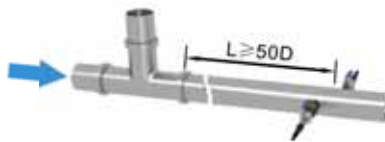

Diffuser

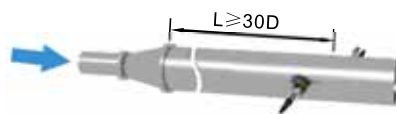

Reduce



Valve



Vertical

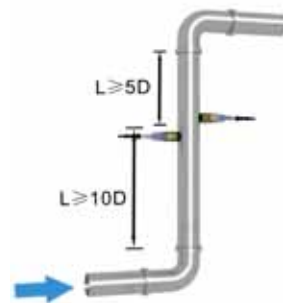

Straight length of downstream piping

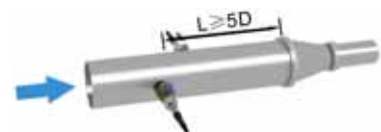
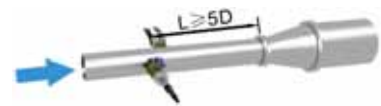
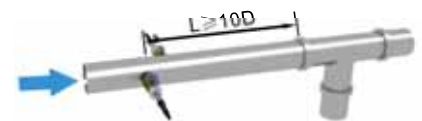
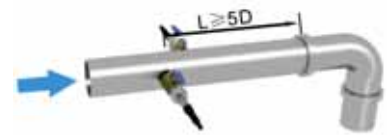

Pump



Ordering Information

Model	Description
D348D Plus	Multipath Ultrasonic Flowmeter Installation Method:Wall mount Flow Range:0.03~±23ft/s(0.01~±7m/s) Accuracy:±0.5% of measured value Repeatability:0.15% Pipe Size Range:4"~200"(100mm~5000mm) Keyboard:24 light tactile keys Display:4.7 inch TFT LCD Power Supply:90-250VAC,48-63Hz
Code	Output
1	4-20mA,OCT pulse output,relay output,RS-232 / RS-458 terminal Modbus Protocol
Code	Transmitter enclosure area classification
1	IP65,die-cast aluminum machined enclosure
2	Explosion-proof enclosure,Exd II BT4
Code	Type of sensor
2	2 channel (pipe size over DN150)
3	3 channel (pipe size over DN300)
4	4 channel (pipe size over DN400)
6	6 channel (pipe size over DN600)
Code	Type of transducers
W210	Wetted transducer,Operating temperature:-40°F~+176°F (-40°C~+80°C)
W110	Wetted transducer,Operating temperature:-40°F~+176°F (-40°C~+80°C)
Code	Transducer Cable Length
030	Standard 30ft(9m)
xxx	Maximum lengthen to 105m(344ft),per 5m is lengthen unit.
Standard Model:D348D Plus-1-1-2-W110-030 Description:Multipath Ultrasonic flowmeter,4-20mA output,two channel path wetted transducer with 9m cable.	